

## GC1616

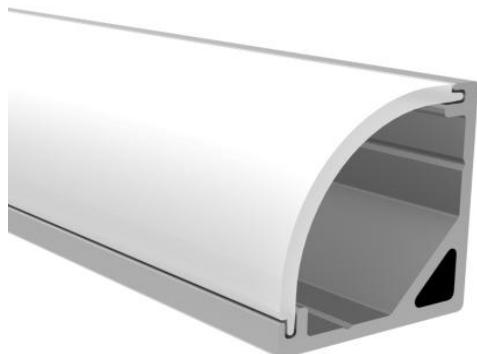

### Features

GC1616 a special local auxiliary lighting system, can be widely used in various interior decoration scenarios and local light spaces. A touch of auxiliary decorative lighting in addition to the basic lighting creates different atmospheres and visual enjoyment.

Embellish life with light that follows you whenever you go.

1、 “Dots-free”lighting

Perfect homogenous lighting.

2、 Various diffuser options

Several options of diffusers, In various shapes and light distribution plans Complete with everything needed

3、 “Two” end caps

Two options of end cap for two ways of wire outgoing, Close-fitting design without screws makes installation much easier

4、 Various installation methods

A wide range of installation accessories wider applications

5、 “One” cut.

Consistent length between diffuser and profile

6、 Smart control for unlimited possibilities

Perfectly match the profiles like customized, Control by hand sweep or touching

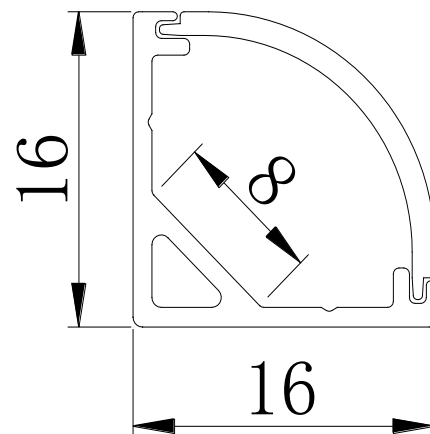

## Details

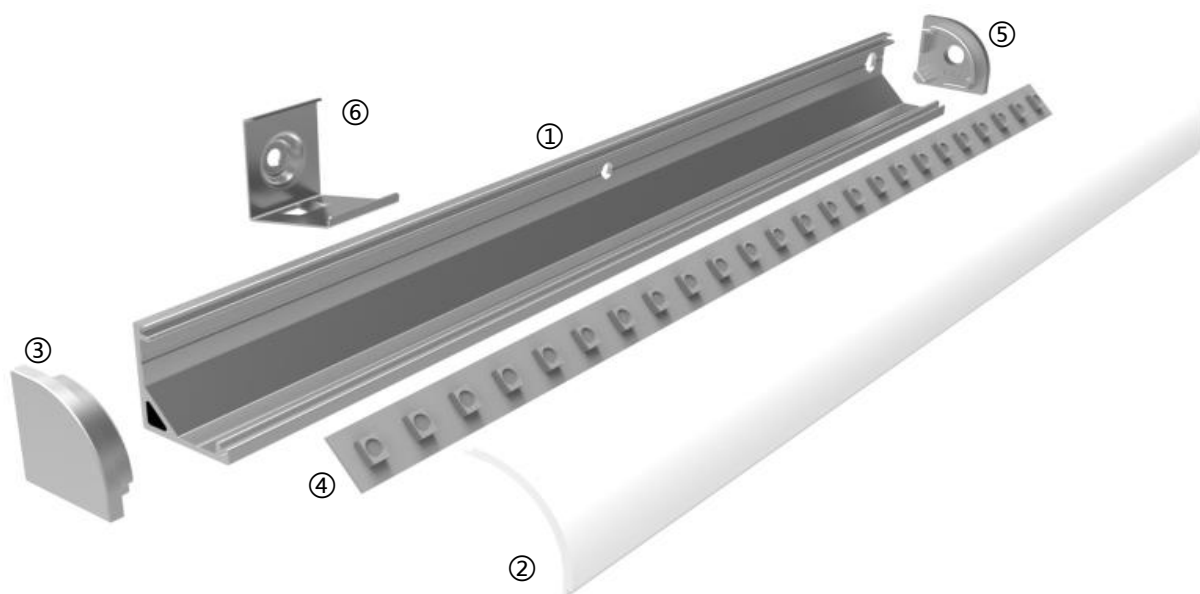

## Standard Configuration



### ① Profile:

Installation: Surface mounted  
 Material: AL6063-T5  
 Applications: Indoors  
 Profile weight: 0.297kg/2.5m  
 Size: L2500\*W16\*H16mm  
 Surface processing: Anodizing

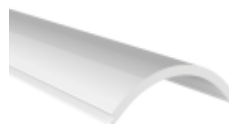

### ② Diffuser:

Type: Frosted diffuse  
 Material: PC  
 Light transmittance : 70%  
 Size : L2500\*W19.2\*H5.9mm  
 (shrink) 0.8mm/m when the temperature rises (drops) 10°C.



### ③ End cap:





Material : fireproof PC  
 Size : L16\*W16\*H6.5mm  
 Surface Technic : Spray paint



### ⑥ Clips:

Material : SUS304  
 Size : L15\*W17\*H17mm

## Optional Accessories

Reference Photo	Name/Model	Size (mm)	Material
	⑤End cap with hole	L16*W16*H6.5mm	fireproof PC
	④FPC strip	Material : FPC , CCT : 2700/3000/4000/5000/6000K ; Ra > 90; Voltage:24V ; Power : 6W/m ; Lumen : 550Lm/m ; PCB width : 8mm ; Minimum cut : 50mm ;	
	④FPC strip	Material : FPC , CCT : 2700/3000/4000/5000/6000K ; Ra > 90; Voltage:24V ; Power : 13W/m ; Lumen : 1050Lm/m ; PCB width : 8mm ; Minimum cut : 50mm ;	
	Power	Three-in-one dimming power driver ( 0-10V、PWM、resistance ) ; size : 363*34.5*22.5mm; white; 65W	

## Optical Parameter

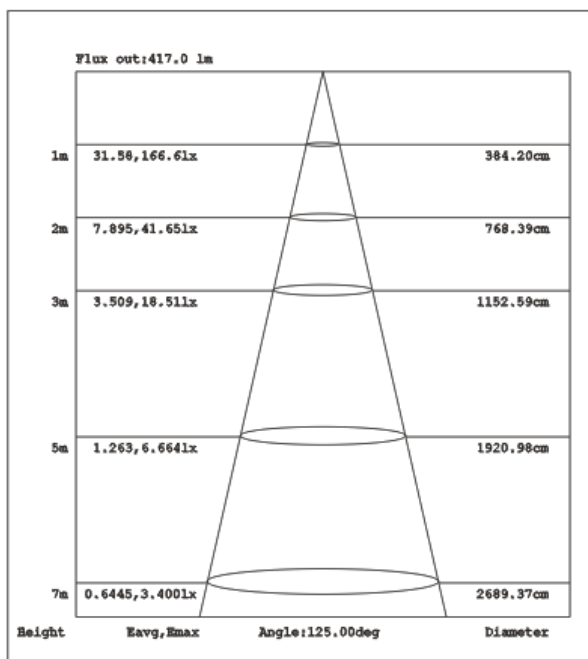
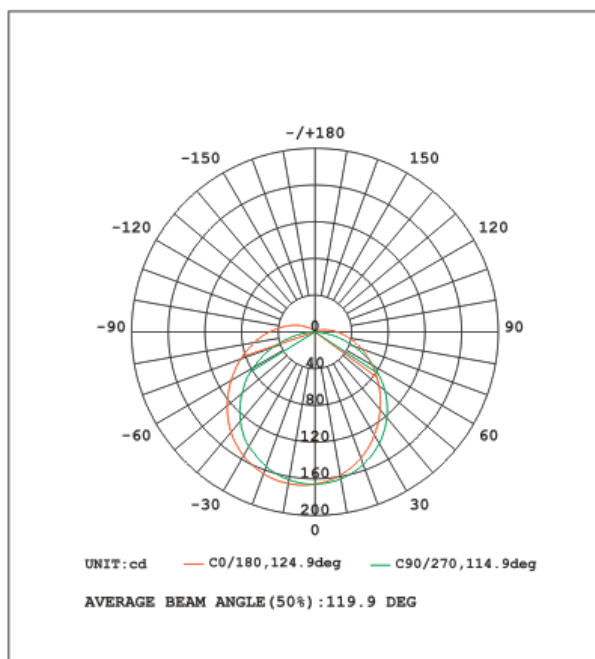

## Package

### 1. Component Packaging

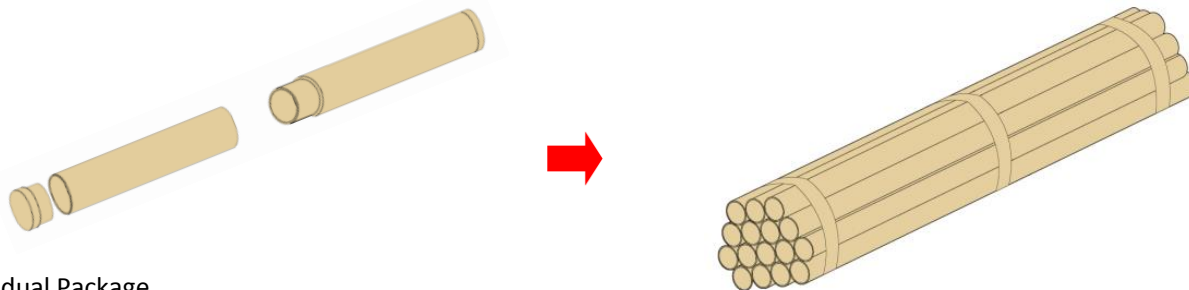

#### Individual Package

Type	Size(mm)	NW(kg)	GW(kg)	Content
Circular cylinder	Φ31*2580	0.45	0.9	1set ( Profile+Diffuser+End cap+Clips )

#### Bundle

CBM(m <sup>3</sup> )	Size(mm)	NW(kg)	GW(kg)	Qty/bundle
0.05	155*124*2580	7.2	14.4	16 set

### 2. Raw Material Packaging

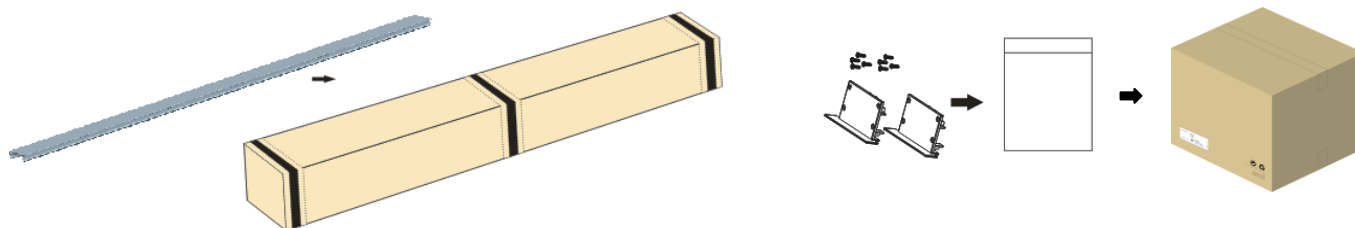

#### Profile Package

Type	Size(mm)	NW(kg)	GW(kg)	Content
packing carton	2580*165*165	29.7	31.9	100Pcs

#### Diffuser Package

Type	Size(mm)	NW(kg)	GW(kg)	Content
Packing box	2564*118*99	16.4	18.7	200Pcs











#### End cap Package

Type	Size(mm)	NW(kg)	GW(kg)	Content
packing carton	250*250*150	0.38	0.83	200Set ( 2Pcs/Set )

#### clips Package

Type	Size(mm)	NW(kg)	GW(kg)	Content
packing carton	250*250*150	1.88	2.27	100Set ( 4Pcs/Set )

Standard product + flexible customization

Profile (component packaging)								
Standard product	Item	Profile	Diffuser	End cap	clips			
	PIC							
	Amount	1 pcs	1 pcs	4 pcs	8 pcs			
Options	NA							
Accessory (raw material packaging)								
Standard product	Item	Profile	Diffuser	End cap	clips	End cap with hole	FPC strip	Power
	PIC							
	Amount	1 pcs	1 pcs	2Pcs/Set	4Pcs/Set	2Pcs/Set	5 m/reel	1 pcs
Standard luminaire (finished luminaries)								
Standard product	Item	2.5m luminaire						
	Amount	1 pcs						
Options	NA							